

Fuel Supply System

PGM-FI Main Relay (cont'd)

Troubleshooting

- Engine will not start.
- Inspection of PGM-FI main relay and relay harness.

Check for an open in the wire:

1. Turn the ignition switch OFF.
2. Disconnect the PGM-FI main relay 4P connector and 8P connector.
3. Check for continuity between the PGM-FI main relay 8P connector terminal No. 7 and body ground.

Is there continuity?

NO

Repair open in the wire between the PGM-FI main relay and G101 (located at right middle of engine).

YES

Check for an open or short in the wire:

Measure voltage between the PGM-FI main relay 4P connector terminal No. 3 and body ground.

Is there battery voltage?

NO

- Replace the ACG(S) (20 A) fuse in the engine compartment fuse/relay box.
- Repair open or short in the wire between the PGM-FI main relay and the ACG(S) (20 A) fuse.

YES

Check for an open or short in the wire:

1. Turn the ignition switch ON (II).
2. Measure voltage between the PGM-FI main relay 8P connector terminal No. 5 and body ground.

Is there battery voltage?

NO

- Replace the No. 2 FUEL PUMP, SRS 2 (15 A) fuse in the under-dash fuse box.
- Repair open or short in the wire between the PGM-FI main relay and the No. 2 FUEL PUMP, SRS 2 (15 A) fuse.

YES

(To page 11-145)

PGM-FI MAIN RELAY 8P CONNECTOR

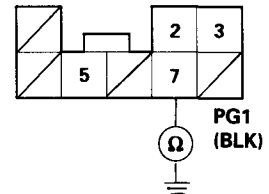

WIRE SIDE OF FEMALE TERMINALS

PGM-FI MAIN RELAY 4P CONNECTOR

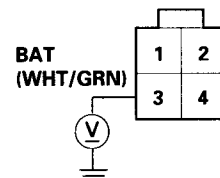

WIRE SIDE OF FEMALE TERMINALS

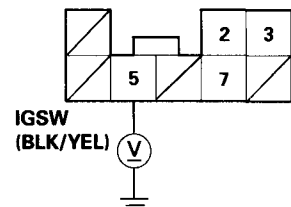



(From page 11-144)

Check for an open in the wire:

Measure voltage between the PGM-FI main relay 4P connector terminal No. 4 and body ground.

Is there battery voltage?

NO

YES

- Replace the IG COIL (30 A) fuse in the engine compartment fuse/relay box.
- Repair open or short in the wire between the PGM-FI main relay and the IG COIL (30 A) fuse.

Check for an open or short in the wire:

1. Turn the ignition switch to the START (III) position.

NOTE:

- M/T: Clutch pedal must be depressed.
- A/T: Transmission in **N** or **P** position.

2. Measure the voltage between the PGM-FI main relay 8P connector terminal No. 3 and body ground.

Is there battery voltage?

NO

YES

- Replace the No. 7 STARTER SIGNAL (7.5 A) fuse in the under-dash fuse box.
- Repair open or short in the wire between the PGM-FI main relay and the No. 7 STARTER SIGNAL (7.5 A) fuse.

Check for an open in the wire:

- Turn the ignition switch OFF.
- Disconnect the ECM connector A (26 P) from the ECM.
- Check for continuity between the PGM-FI main relay 8P connector terminal No. 2 and ECM connector terminal A4.

Is there continuity?

NO

YES

Repair open in the wire between the ECM (A4) and the PGM-FI main relay.

(To page 11-146)

PGM-FI MAIN RELAY 4P CONNECTOR

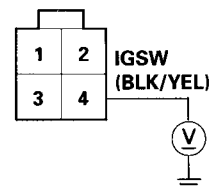

WIRE SIDE OF FEMALE TERMINALS

PGM-FI MAIN RELAY 8P CONNECTOR

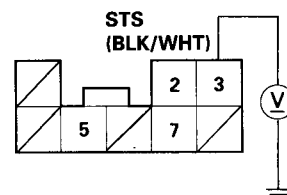

WIRE SIDE OF FEMALE TERMINALS

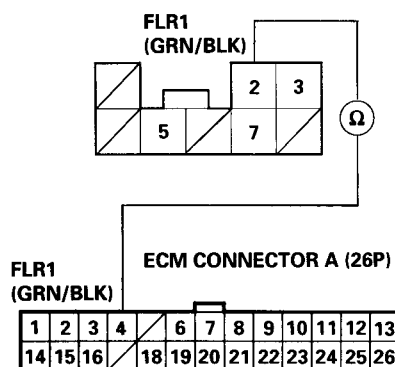

WIRE SIDE OF FEMALE TERMINALS

(cont'd)

Fuel Supply System

PGM-FI Main Relay (cont'd)

(From page 11-145)

Check for an open in the wire:

1. Reconnect the ECM connector A (26P).
2. Reconnect the PGM-FI main relay 4P and 8P connectors.
3. Turn the ignition switch ON (II).
4. Measure voltage between ECM connector terminals A13, C1, and A12.

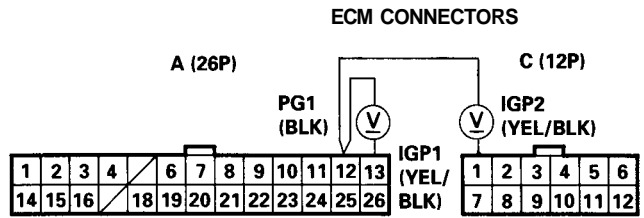

WIRE SIDE OF FEMALE TERMINALS

Is there battery voltage?

NO

- Repair open in the wire between the ECM (A13, CD and the PGM-FI main relay.
- Replace the PGM-FI main relay.

YES

Check for an open in the ECM:

1. Turn the ignition switch OFF.
2. Measure voltage between ECM connector terminals A4 and A12 when the ignition switch is first turned on for two seconds.

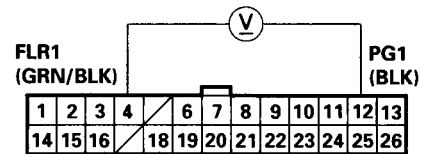

Is there 1.0 V or less?

NO

Substitute a known-good ECM and recheck. If prescribed voltage is now available, replace the original ECM.

YES

Check the PGM-FI main relay (see page 11-143).